

PKG-341-MBC08-PS-CBL

System Diagram and Specifications

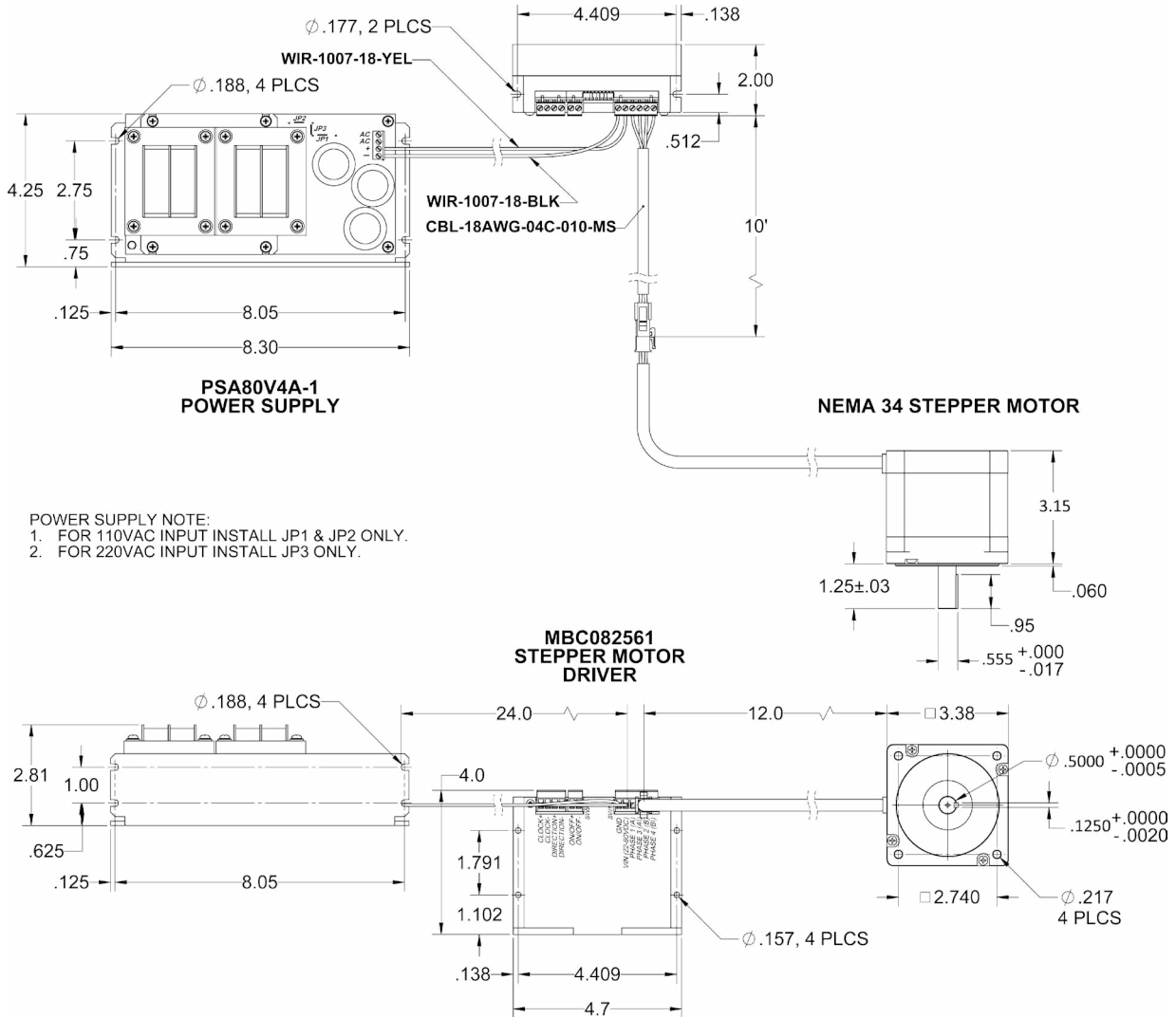

Included Components:	
34Y112S-LW8-MS	Stepper Motor
MBC082561	Stepper Driver
PSA80V4A-1	Power Supply
CBL-18AWG-04C-010-MS	Motor Cable
WIR-1007-18-YEL	Power Wire
WIR-1007-18-BLK	Power Wire

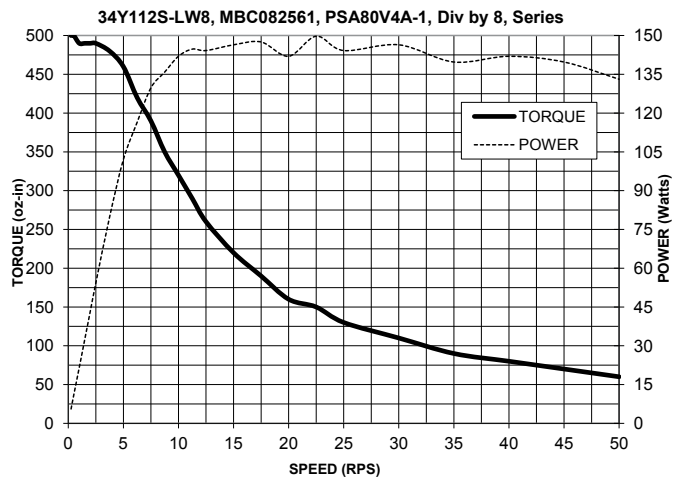

L010870

34Y112S-LW8-MS - High Torque Stepper Motor



FEATURES

- **NEMA 34 Frame Size**
- **Holding Torque - 637 oz-in**
- **1.8° Step Angle**
- **High Step Accuracy and Resolution**
- **Low Vibration and Noise**
- **CE Certified RoHS Compliant**



The 34Y112S-LW8-MS High Torque Stepper Motor offers a great value without sacrificing quality. This motor was designed to offer the highest possible torque while minimizing vibration and audible noise. It is wired in series with a Molex 4 pin Mini-Fit Jr. receptacle.

A 10 ft. 4 conductor, 18 AWG cable with mating 4 pin Mini-Fit Jr plug is included in the PKG-341-MBC08-PS-CBL stepper/motor package.

SPECIFICATIONS/DIMENSIONS

Model #	NEMA Size	Holding Torque (oz-in)	Bipolar Current (A)	Bipolar Resistance (ohms)	Bipolar Voltage (v)	Bipolar Inductance (mH)	Rotor Inertia (oz-in-sec ²)	Shaft Diameter (in)	Weight (lbs)	Length (in)
34Y112S-LW8-MS	34	637	4.3	0.78	3.35	6.8	.0198	0.5	5.1	3.15

Step Angle Accuracy:	± 5% (Full Step, No Load)	Insulation Resistance:	100M Ohm Min, 500VDC
Resistance Accuracy:	± 10%	Dielectric Strength:	500VDC for 1 minute
Inductance Accuracy:	± 20%	Shaft Radial Play:	0.02" Max (1.0 lbs)
Temperature Rise:	80°C Max (2 Phases On)	End Play:	0.08" Max (1.0 lbs)
Ambient Temperature:	-20° to +50° C	Max Radial Force:	49.5 lbs (0.79" from flange)
Insulation Type:	Class B	Max Axial Force:	13.5 lbs-Force

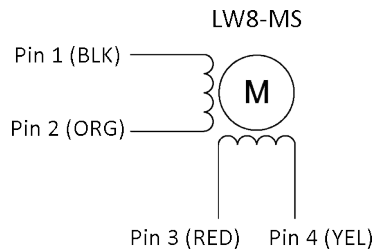

Pin #	Lead Wire Connection	Lead Wire Color
1	Phase 1 (A)	Black
2	Phase 3 (A)	Orange
3	Phase 2 (B)	Red
4	Phase 4 (B)	Yellow
	Soldered Together	White/Black & White/Orange
	Soldered Together	White/Red & White/Yellow

MBC082561 - Microstep Driver



FEATURES

- Size 4.685”L x 2.000”W x 4.000”H
- Output Current 7.8 Amps Peak
- 400 to 51,200 steps/rev
- Over-Voltage, Under Voltage and Short Circuit Protection
- Selectable Stand Still Current Reduction
- No Minimum Inductance
- Optical Isolation
- Motor ON/OFF Input

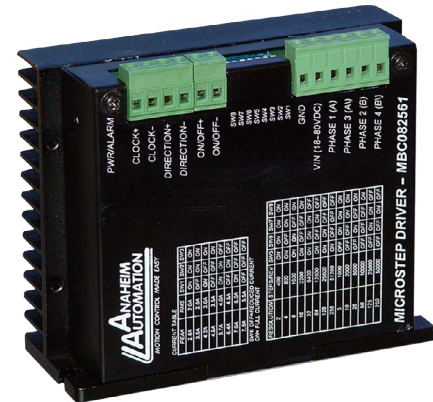

DESCRIPTION

The MBC082561 Microstep Driver has an output current capability of 2.8 Amps minimum to 7.8 Amps maximum (Peak Rating). The MBC082561 driver operates on a DC voltage of 22-90 volts. The inputs are optically isolated with a minimum sourcing of 15.0 mA per input @ 5+VDC. The clock input is set to receive either positive or negative edge clocks with a maximum frequency of 400kHz. The MBC082561 driver offers direction control and motor current ON/OFF capabilities. The Reduce Current Enabled automatically reduces motor current to 60% of set value after the last step is made (1sec delay). The driver has built-in features to indicate power on (Green LED) and fault conditions (Red LED)

With the MBC082561, various step resolutions can be implemented by the onboard dip switch. These division range from 400 steps per revolution to 51,200 steps per revolution. The bipolar drive configuration handles 4, 6 and 8 lead motors. Protection devices have been added to this driver for *Short-Circuit*, *Motor Mis-Wire*, *Over-Voltage* and *Under Voltage* conditions.

SPECIFICATIONS

Power Requirements:	22-90VDC
Output Current Range:	2.8-7.8Amps (Peak)
Microstepping Resolution:	400-51,200 Steps/Rev
Input Signal Voltage:	3.5-5VDC
Input Clock Frequency:	0-400kHz
Storage Temperature:	0-50°C
Absolute Maximum Driver Temperature:	65°C

TYPICAL APPLICATION HOOK-UP

SINKING OUTPUTS:

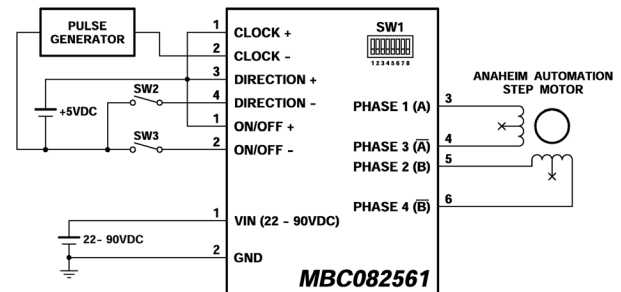

SOURCING OUTPUTS:

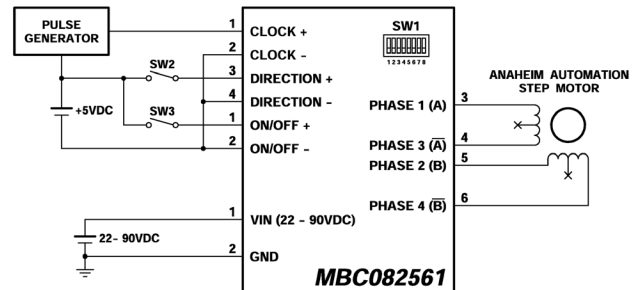

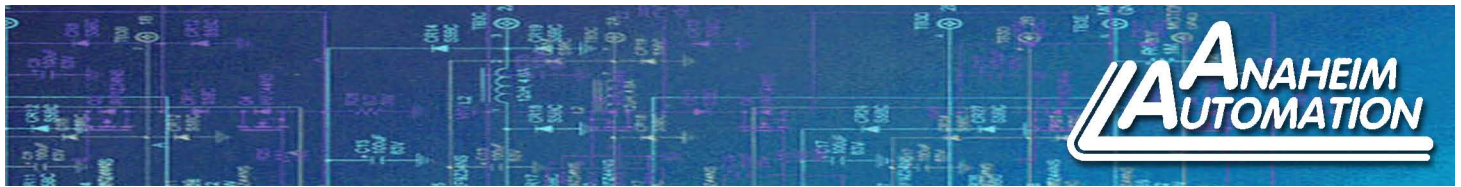

Connecting the Step Motor

Phase 1 (A) and Phase 3 (A\ of the Step Motor is connected between pins 3 and 4 on the motor connector (TB3). Phase 2 (B) and Phase 4 (B\ of the Step Motor is connected between pins 5 and 6 on the motor connector (TB3). Refer to TYPICAL APPLICATION HOOK-UP.

NOTE: The physical direction of the motor with respect to the direction input will depend on the connection of the motor windings. To reverse the direction of the motor with respect to the direction input, switch the wires on Phase 1 (A) and Phase 3 (A\.

Short-Circuit, Mis-Wire, and Over Current Conditions

If there is a condition that causes an over current in the driver phase transistors, the alarm indicator LED will turn red and power will be shut off to the motor. To reset the drive turn power off, check wiring, and turn power back on.

Over-Voltage and Under-Voltage Conditions

When the power supply voltage exceeds +90VDC, protection will be activated and the alarm indicator LED will turn red. When the power supply voltage is lower than +22VDC, the driver will not work properly.

Optically Isolated Input Pin Descriptions

The inputs on the MBC082561 are optically isolated with the anode (+) and cathode (-) both brought out to the user. With no current going through the opto-diode, the input is considered high. To enable the input a minimum of 7.0 mA needs to be sourced or sunk through the opto-diode. This is done simply by placing a voltage of +5VDC across the two inputs of the opto-diode. If sourcing current into the inputs, then all three cathodes (-) should be tied together and grounded. If sinking current, then all three anodes (+) should be tied together to the +voltage. See TYPICAL APPLICATION HOOK-UP diagram.

TB1 and TB2: 4 and 2 Pin Terminal Description

Pin #	Description
1	Step Clock Input Anode (+): A positive going edge on this isolated input advances the motor one increment. The size of the increment is dependent of the Microstep Select Inputs of Switch 1.
2	Step Clock Input Cathode (-)
3	Direction Anode (+): This isolated input is used to change the direction of the motor. Physical direction also depends on the connection of the motor windings.
4	Direction Cathode (-)
1	ON/OFF Anode (+): This isolated input is used to enable and disable the output section of the driver. When HIGH (open) the outputs are enabled.
2	ON/OFF Cathode (-)

TB3: 6 Pin Terminal Description

Pin #	Description
1	GND: Power Return
2	VIN: (+22 to +90VDC)
3	Phase A: Phase 1 of the Step Motor
4	Phase A\: Phase 3 of the Step Motor
5	Phase B: Phase 2 of the Step Motor
6	Phase B\: Phase 4 of the Step Motor

Setting the Output Current:

The output current for the motor used when microstepping is determined differently from that of a full/half step unipolar driver. In the MBC082561, a sine/ cosine output function is used in rotating the motor. The output current for a given motor is determined by the motors current rating and the wiring configuration of the motor. There are 3 DIP switches used to set the output current of the MBC082561. This sets the peak output current of the sine/cosine waves.

The specified motor current of 4.3 for the 34Y112S-LW8-MS (which is the bipolar value) is multiplied by a factor of 1.4 to determine the peak value of 6.0Amps. The 3 switches should be set to ON, ON, OFF to select the current value of 5.7A to avoid burning up the motor.

Peak Current	RMS Current	SW 1	SW 2	SW 3
2.8A	2.0A	ON	ON	ON
3.5A	2.5A	OFF	ON	ON
4.2A	3.0A	ON	OFF	ON
4.9A	3.5A	OFF	OFF	ON
5.7A	4.0A	ON	ON	OFF
6.4A	4.5A	OFF	ON	OFF
7.0A	5.0A	ON	OFF	OFF
7.8A	5.5A	OFF	OFF	OFF

Reducing the Output Current:

Switch 4 is used for enabling or disabling the reduced current at standstill. When this switch is off, the driver will be in reduced current setting and the standstill current will be 60% of the set motor current. When this switch is on, the driver will not be in reduced mode and the standstill current will be 100% of the set motor current.

WARNINGS:

Do not set the current setting above the step motor's rated current. When using a higher current setting into a motor, the motor will overheat and burnup. Should this occur, the driver will also be damaged.

Do not connect or disconnect motor wires while power is applied! Doing so will cause an extremely high back-EMF voltage surge which could possibly destroy the driver.

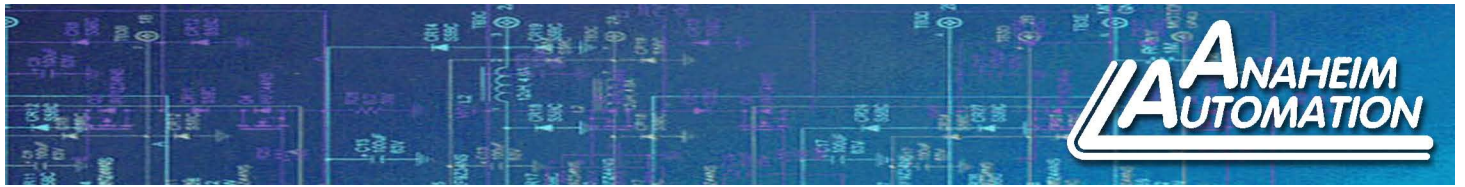

Microstepping Selection (DIP Settings)

Switches 2, 3, and 4 of the DIP switch select the microstep resolution of the driver. The table below shows the standard resolution values along with the associated positions for the select switches. The standard waveforms are sinusoidal. The steps/rev are based on a 200 step/rev motor.

Resolution	Steps/Rev	Position 1	Position 2	Position 3	Position 4	Auto Reduce Current
1	200	OFF	ON	ON	ON	Disabled
2	400	OFF	ON	ON	OFF	Disabled
5	1000	OFF	ON	OFF	ON	Disabled
8	1600	OFF	ON	OFF	OFF	Disabled
10	2000	OFF	OFF	ON	ON	Disabled
16	3200	OFF	OFF	ON	OFF	Disabled
32	6400	OFF	OFF	OFF	ON	Disabled
64	12800	OFF	OFF	OFF	OFF	Disabled
1	200	ON	ON	ON	ON	Enabled
2	400	ON	ON	ON	OFF	Enabled
5	1000	ON	ON	OFF	ON	Enabled
8	1600	ON	ON	OFF	OFF	Enabled
10	2000	ON	OFF	ON	ON	Enabled
16	3200	ON	OFF	ON	OFF	Enabled
32	6400	ON	OFF	OFF	ON	Enabled
64	12800	ON	OFF	OFF	OFF	Enabled

PSA80V4A-1 - Power Supply



FEATURES

- **Low Cost**
- **High Reliability**
- **Short Circuit**
- **Overload Protection**



DESCRIPTION

The PSA80V4A-1 power supply has a single 80V output, a voltage input of 115 or 220VAC, and power capabilities of up to 320 watts. With an unregulated output and a size of 8.30" x 4.25" x 2.81" and dual mounting position "L Bracket," the PSA80V4A-1 can be mounted just about anywhere. The PKG-341-MBC08-PS-CBL includes two wires for powering the MBC12101.

DIMENSIONS/SPECIFICATIONS

DC Voltage Output:	80V
Output Rated Current:	4A
Input Voltage Range:	115/220VAC, 60 Hz
Rated Output Power:	320W

